

10L2w Transducer



LEGAL MANUFACTURER

BK Medical Aps
Mileparken 34
2730 Herlev
Denmark
Tel.:+45 44528100 / Fax:+45 44528199
www.bkmedical.com
Email: info@bkmedical.com

The connector label on a BK Medical transducer contains information about the date of manufacture.

BK Medical Customer Satisfaction

Input from our customers helps us improve our products and services. Your opinions are important to us. You are always welcome to contact us via your BK representative or by contacting us directly.

10L2w = Ref. Type 9022

Contents

- Introduction 3
 - Intended use 3
 - Indications for use 3
- General Information 3
 - Service and Repair 4
 - Caring for the Transducer. 4
- Reprocessing 4
- Starting Imaging 5
 - Connecting the Transducer. 5
 - Changing Frequency. 5
 - Using a Transducer Cover 5
 - Using the Transducer Control Button. 6
 - Changing Orientation 6
- Puncture and Biopsy Facilities 6
 - Puncture Guide Attachment UA1239. 6
- Performing Puncture and Biopsy. 8
 - Cleaning after Puncture and Biopsy. 9
- Disposal. 10

Introduction

This is the user guide for the 10L2w transducer, and it must be used together with the *Care and Cleaning* user guide which contains important safety information.

 Physicians only	Caution Rx-c1 United States Federal law restricts this device to sale by or on the order of a physician.
---	--

Intended use

The transducer is intended for diagnostic ultrasound imaging or fluid flow analysis of the human body.

Indications for use

10L2w is suitable for deep vein and peripheral vessel (peripheral vascular) examinations. It is also suitable for elastography and vector flow imaging (VFI).

Patient Population

The patient population is adults.

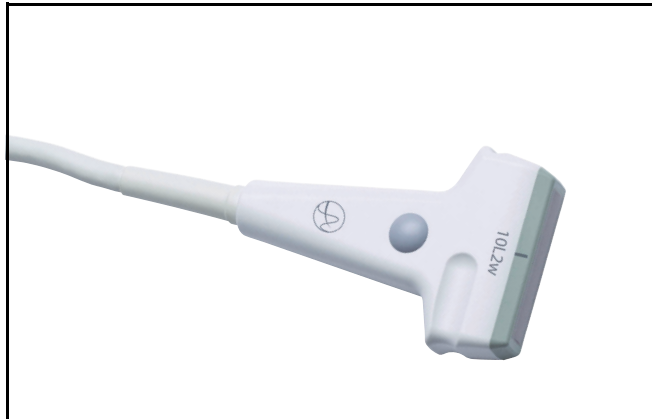

Figure 1. 10L2w transducer

General Information

Product specifications, acoustic output data and data about EMC (electromagnetic compatibility) for this transducer can be found in the *Product Data Sheet* and the *Technical Data (BZ2100)* that accompany this user guide.

**WARNING GS-w2**

If at any time the system malfunctions, or the image is severely distorted or degraded, or you suspect in any way that the system is not functioning correctly:

- Remove all transducers from contact with the patient.
- Turn off the system. Unplug the system from the wall and make sure it cannot be used until it has been checked.
- Do not try to repair the system yourself.
- Contact your BK service representative or hospital technician.

**WARNING AO-w1**

To avoid tissue damage, always keep the exposure level (the acoustic output level and the exposure time) as low as possible.

Service and Repair

**WARNING SR-w1**

Service and repair of BK electromedical equipment must be carried out only by the manufacturer or its authorized representatives. BK Medical reserves the right to disclaim all responsibility, including but not limited to responsibility for the operating safety, reliability and performance of equipment serviced or repaired by other parties. After service or repairs have been carried out, a qualified electrician or hospital technician should verify the safety of all equipment.

Caring for the Transducer

The transducer may be damaged during use or reprocessing, so it must be checked before use for cracks or irregularities in the surface, following the procedure in *Care and Cleaning*. It should also be checked thoroughly once a month following the same procedure.

Reprocessing

To ensure the best results when using BK Medical equipment, it is important to maintain a strict cleaning routine.

Complete details and procedures can be found in *Care and Cleaning* that accompanies this user guide.

A list of reprocessing methods that the transducer can withstand are listed in the *Product Data Sheet*.

Sterile covers are available. See the *Product Data Sheet* for more information.

**WARNING Reproc-w2**

Users of this equipment have an obligation and responsibility to provide the highest possible degree of infection control to patients, co-workers and themselves. The instructions in this book are meant as a guide. To avoid cross-contamination, follow all infection control policies (including for reprocessing, packing and storage) for personnel and equipment that have been established for your office, department or hospital.

Starting Imaging

Before use, all equipment must be reprocessed according to expected use.

**WARNING T-w5**

To prevent electrical shock and damage to the transducer, the connector pins in the transducer plug must always be completely dry before you connect to a system.

Connecting the Transducer

**WARNING GS-w4a**

It is essential for the patient's safety that only the correct equipment is used.

- Do not use other manufacturers' transducers with BK ultrasound systems.
- Do not use BK transducers with other manufacturers' systems.
- Do not use unauthorized combinations of transducers and needle guides.

The transducer is connected to the system using the array transducer socket on the system. To connect, flip the system's locking lever to the right. Align the transducer plug to the system socket and insert securely. Flip the system's locking lever to the left to lock it.

When connected, the transducer complies with Type BF requirements of EN60601-1 (IEC 60601-1).

Changing Frequency

The multifrequency imaging (MFI) control enables you to select the imaging frequency. See the applicable system user guide for instructions.

Using a Transducer Cover

BK recommends the use of a sterile transducer cover to reduce the risk of cross-contamination. See the **Product Data Sheet** for a list of available transducer covers. Follow local guidelines for the use of transducer covers in your area.

NOTE: *In the United States of America, it is recommended to use transducer covers that have been market cleared. In Canada, use only licensed transducer covers. In Europe, transducer covers must be CE-marked.*

**WARNING TC-w1**

Some transducer covers can contain latex. Because of reports of severe allergic reactions to medical devices containing latex (natural rubber), the FDA advises health-care professionals to identify their latex-sensitive patients and be prepared to treat allergic reactions promptly.

Apply sterile gel to the tip of the transducer or fill the cover with 1 to 2 ml of sterile water. This improves screen imaging by preventing image artifacts caused by air bubbles.

Gel also creates a good acoustic contact between the skin and the transducer; therefore, apply a small amount to the outside of the cover prior to imaging and re-apply frequently.

Follow these precautions when putting sterile covers on a transducer:

- Wear sterile gloves.
- When using a puncture attachment, place it gently over the cover and secure it, following the instructions for the puncture attachment.
- Verify that the cover has not been damaged in the process. If it has, repeat the procedure with a new transducer cover.

**Caution T-c3**

Use only water-based gel (sterile if you are using a sterile transducer cover). Products containing parabens, petroleum, or mineral oils may harm the transducer or transducer cover.

Using the Transducer Control Button

The control button on the transducer controls the imaging.

Press the button to **Start** or **Stop** imaging (freeze frame). Press the button for more than one second to make a copy of the image.

Changing Orientation

To change the orientation of the image on the monitor, refer to the applicable system user guide for instructions.

Puncture and Biopsy Facilities

Puncture and biopsy are possible with the 10L2w transducer. The puncture attachment is illustrated in the following pages with a brief description of its use and operating instructions.

Puncture Guide Attachment UA1239

The UA1239 needle guide (Fig. 2) is designed for guiding puncture and biopsy when used with 10L2w (Fig. 3).

It consists of:

- A bracket for attaching the needle holder to the transducer.
- The needle holder, which features a three-winged shaft that can be rotated in the barrel of the needle holder to accommodate different sized needles.

Use the screw to adjust the angle of penetration.

Use 0.9 mm (20 Gauge), 1.3 mm (18 Gauge), or 2.1 mm (14 Gauge) needles with the needle guide.

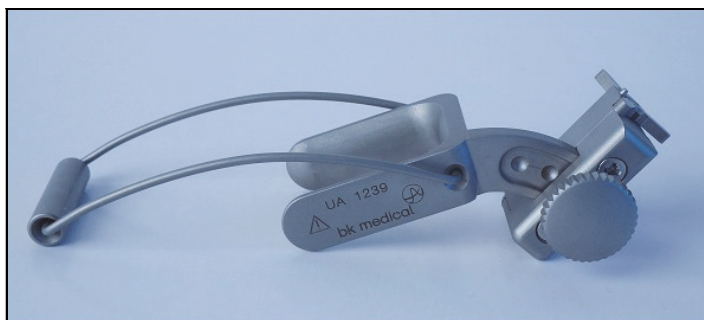

Figure 2. Needle guide UA1239.

The bracket has a 30°, 45°, or 60° angle of insertion to the image axis; these are shown on the image as lines of dots.

To mount UA1239:

- 1 Hold the transducer in your left hand with the transducer control button facing away from you.
- 2 Hold the UA1239 in your right hand with the adjusting screw facing towards you, the two “legs” pointing to the left, and the movable swing arm pointing down.
- 3 Slide the two legs down over the transducer into the recessed grooves.
- 4 Lock the swing arm into position at the neck end of the transducer. An audible click indicates when the needle guide is securely attached.



Figure 3. The needle guide mounted on 10L2w.

To alter the angle of the needle-guide holder:

- 1 Loosen the adjustable screw by turning it one quarter revolution counter-clockwise.
- 2 Select the desired angle (60°, 45°, 30°).
- 3 Re-tighten the adjustable screw.

To select the correct needle barrel:

- 1 Raise the three-winged handle up out of its socket and rotate it until the desired barrel is next to the small, black triangular marking on the top of the needle guide holder.
- 2 Push the three-winged handle fully back down into its socket.
- 3 Slide in the desired needle (or catheter).

To detach the needle during interventional procedures:

- 1 Raise the three-winged handle approximately 3 mm and rotate counter-clockwise through 60° until halted by the small metal nub.
- 2 The needle (or catheter) can now be released from the needle guide attachment.

All parts of the needle guide can be autoclaved or disinfected by immersion in a suitable solution.

Performing Puncture and Biopsy

	<p>WARNING P-w1</p> <p>Before you start imaging, verify that the type number or name of the transducer and the type number or description of the needle guide you are using match the number displayed on the monitor. Also make sure that the needle guide is positioned correctly. If the numbers do not match, or if the needle guide position is not correct, the puncture line on the monitor may not correspond to the true puncture path in the tissue. In case of any inconsistency, stop imaging, turn off the system, and contact your BK service representative.</p>
---	--

	<p>WARNING P-w4</p> <p>The puncture line on the image is an indication of the expected needle path. To avoid harming the patient, the needle tip echo should be monitored at all times so any deviation from the desired path can be corrected.</p>
---	--

If the transducer is not sterilized, cover it with a sterile transducer cover.

If the transducer cover is damaged when attaching the puncture attachment, replace it with a new cover.

See the *Product Data Sheet* for a list of available transducer covers.

Press the **Puncture** or **Biopsy** control on the system to superimpose a puncture line on the scan image.

If more than one puncture line is available, refer to the applicable system user guide for instructions on how to change which one appears.

Move the transducer until the puncture line transects the target. Insert the needle and monitor as it moves along the puncture line to the target. The needle tip echo will be seen as a bright dot on the screen.

	<p>WARNING TC-w4</p> <p>If you detach the needle guide during interventional procedures, the transducer cover could be damaged. To avoid cross-contamination, cover the transducer with a new transducer cover before reattaching the needle guide.</p>
---	--

To remove the puncture line from the scan image, refer to the applicable system user guide for instructions.

	<p>WARNING P-w5</p> <p>Avoid unnecessary tissue damage. When performing a biopsy, always make sure that the needle is fully drawn back inside the needle guide before moving the transducer.</p>
---	---

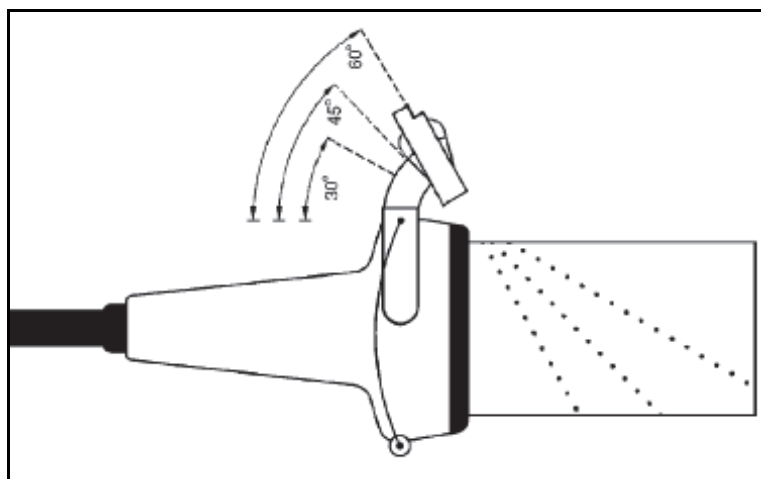



Figure 4. Puncture lines for UA1239 on 10L2w

Cleaning after Puncture and Biopsy

	<p>WARNING Reproc-w3</p> <p>Immediately after use, you must pre-clean the device until visually clean (including device lumens if existing). Conduct the thorough cleaning process as soon as possible after use in order to prevent bioburden drying on the surface. Dried bioburden can lead to inefficient cleaning, disinfection and sterilization, causing a risk of cross-contamination.</p>
---	---

Use a suitable brush to make sure that biological material and gel are removed from all channels and grooves. See *Care and Cleaning* for cleaning instructions.

Disposal

When the transducer is scrapped at the end of its life, national rules for the relevant material in each individual land must be followed. Within the EU, when you discard the transducer, you must send it to appropriate facilities for recovery and recycling.

	<p>WARNING D-w1</p> <p>For disposal of contaminated items such as transducer covers or needle guides or other disposable items, follow disposal control policies established for your office, department or hospital.</p>
---	--

 BK Medical ApS, Mileparken 34, 2730 Herlev, Denmark. T +45 4452 8100 F +45 4452 8199



BK Medical
8 Centennial Drive
Peabody
MA01960
USA
T + 1 978-326-1300
bkmedical.com

**USA
Sales & Service**
BK Medical
8 Centennial Drive
Peabody
MA01960
USA
T + 1 978-326-1300
F + 1 978-326-1399
bkmedical.com

**Europe and Rest of World
Sales, Service & Design Center**
BK Medical
8 Centennial Drive
Mileparken 34
2730 Herlev
Denmark
T +45 4452 8100
F +45 4452 8199
bkmedical.com

**China
Sales & Service**
Analogic Medical Equipment (Shanghai) Co., Ltd.
1377, Lan Dian Road
Pu Dong New District Shanghai
China 201132
T +86 21 2089 0333
bkmedical.com
T 021-20890333
bkmedical.com